

MITSUBISHI HVIGBT MODULES
CM1200HCB-34N

4th-Version HVIGBT (High Voltage Insulated Gate Bipolar Transistor) Modules

HIGH POWER SWITCHING USE
 INSULATED TYPE

CM1200HCB-34N



- IC 1200A
- VCES 1700V
- Insulated Type
- 1-element in a Pack
- AISiC Baseplate
- Trench Gate IGBT : CSTBT™
- Soft Reverse Recovery Diode

APPLICATION

Traction drives, High Reliability Converters / Inverters, DC choppers

OUTLINE DRAWING & CIRCUIT DIAGRAM

Dimensions in mm

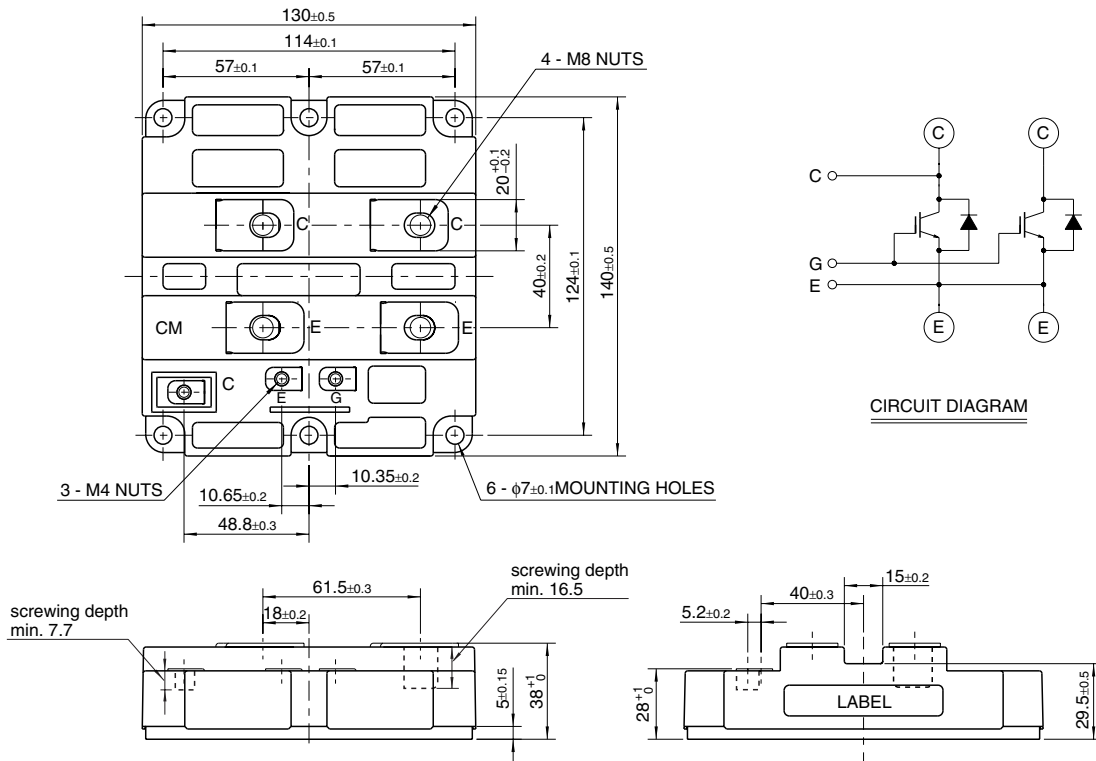

HVIGBT (High Voltage Insulated Gate Bipolar Transistor) Modules

CM1200HCB-34N

**HIGH POWER SWITCHING USE
INSULATED TYPE**

4th-Version HVIGBT (High Voltage Insulated Gate Bipolar Transistor) Modules

MAXIMUM RATINGS

Symbol	Item	Conditions	Ratings	Unit
V _{CES}	Collector-emitter voltage	V _{GE} = 0V, T _J = 25°C	1700	V
V _{GES}	Gate-emitter voltage	V _{CE} = 0V, T _J = 25°C	± 20	V
I _C	Collector current	DC, T _c = 80°C	1200	A
I _{CM}		Pulse (Note 1)	2400	A
I _E	Emitter current (Note 2)	DC	1200	A
I _{EM}		Pulse (Note 1)	2400	A
P _c	Maximum power dissipation (Note 3)	T _c = 25°C, IGBT part	8600	W
V _{iso}	Isolation voltage	RMS, sinusoidal, f = 60Hz, t = 1 min.	4000	V
T _J	Junction temperature		-40 ~ +150	°C
T _{op}	Operating temperature		-40 ~ +125	°C
T _{stg}	Storage temperature		-40 ~ +125	°C
t _{psc}	Maximum short circuit pulse width	V _{CC} = 1000V, V _{CE} ≤ V _{CES} , V _{GE} = 15V, T _J = 125°C	10	μs

ELECTRICAL CHARACTERISTICS

Symbol	Item	Conditions	Limits			Unit	
			Min	Typ	Max		
I _{CES}	Collector cutoff current	V _{CE} = V _{CES} , V _{GE} = 0V	T _J = 25°C	—	—	5	mA
			T _J = 125°C	—	4.0	10	
V _{GE(th)}	Gate-emitter threshold voltage	V _{CE} = 10 V, I _C = 120 mA, T _J = 25°C	5.5	6.5	7.5	V	
I _{GES}	Gate leakage current	V _{GE} = V _{GES} , V _{CE} = 0V, T _J = 25°C	—	—	0.5	μA	
C _{ies}	Input capacitance	V _{CE} = 10 V, V _{GE} = 0 V, f = 100 kHz, T _J = 25°C	—	220	—	nF	
C _{oes}	Output capacitance		—	12	—	nF	
C _{res}	Reverse transfer capacitance		—	3.5	—	nF	
Q _g	Total gate charge	V _{CC} = 900 V, I _C = 1200 A, V _{GE} = ±15 V, T _J = 25°C	—	15.2	—	μC	
V _{CE(sat)}	Collector-emitter saturation voltage	I _C = 1200 A (Note 4) V _{GE} = 15 V	T _J = 25°C	—	2.05	2.70	V
			T _J = 125°C	—	2.30	—	
t _{d(on)}	Turn-on delay time	V _{CC} = 900 V, I _C = 1200 A, V _{GE} = ±15 V R _{G(on)} = 1.1 Ω, T _J = 125°C, L _s = 100 nH	—	—	1.50	μs	
t _r	Turn-on rise time		—	—	0.60	μs	
E _{on(10%)}	Turn-on switching energy (Note 5)		Inductive load	—	0.43	—	J/P
t _{d(off)}	Turn-off delay time	V _{CC} = 900 V, I _C = 1200 A, V _{GE} = ±15 V R _{G(off)} = 2.0 Ω, T _J = 125°C, L _s = 100 nH	—	—	3.00	μs	
t _f	Turn-off fall time		—	—	0.60	μs	
E _{off(10%)}	Turn-off switching energy (Note 5)		Inductive load	—	0.32	—	J/P
V _{EC}	Emitter-collector voltage (Note 2)	I _E = 1200 A (Note 4) V _{GE} = 0 V	T _J = 25°C	—	2.20	3.00	V
			T _J = 125°C	—	1.85	—	
t _{rr}	Reverse recovery time (Note 2)	V _{CC} = 900 V, I _E = 1200 A, V _{GE} = ±15 V R _{G(on)} = 1.1 Ω, T _J = 125°C, L _s = 100 nH	—	—	1.50	μs	
Q _{rr}	Reverse recovery charge (Note 2)		Inductive load	—	410	—	μC
E _{rec(10%)}	Reverse recovery energy (Note 2), (Note 5)		Inductive load	—	0.29	—	J/P

CM1200HCB-34N

**HIGH POWER SWITCHING USE
INSULATED TYPE**

4th-Version HVIGBT (High Voltage Insulated Gate Bipolar Transistor) Modules

THERMAL CHARACTERISTICS

Symbol	Item	Conditions	Limits			Unit
			Min	Typ	Max	
$R_{th(j-c)Q}$	Thermal resistance	Junction to Case, IGBT part	—	—	14.0	K/kW
$R_{th(j-c)R}$	Thermal resistance	Junction to Case, FWDi part	—	—	21.0	K/kW
$R_{th(c-f)}$	Contact thermal resistance	Case to Fin, $\lambda_{grease} = 1W/m-K$, $D_{(c-f)} = 100 \mu m$	—	10.0	—	K/kW

MECHANICAL CHARACTERISTICS

Symbol	Item	Conditions	Limits			Unit
			Min	Typ	Max	
M_t	Mounting torque	M8: Main terminals screw	7.0	—	13.0	N·m
M_s		M6: Mounting screw	3.0	—	6.0	N·m
M_t		M4: Auxiliary terminals screw	1.0	—	2.0	N·m
m	Mass		—	1.5	—	kg
CTI	Comparative tracking index		600	—	—	—
d_a	Clearance		19.5	—	—	mm
d_s	Creepage distance		32.0	—	—	mm
LP CE	Parasitic stray inductance		—	15	—	nH
R_{CC+EE}	Internal lead resistance	$T_c = 25^\circ C$	—	0.21	—	mΩ

- Note 1. Pulse width and repetition rate should be such that junction temperature (T_j) does not exceed T_{opmax} rating (125°C).
 2. The symbols represent characteristics of the anti-parallel, emitter to collector free-wheel diode (FWDi).
 3. Junction temperature (T_j) should not exceed T_{jmax} rating (150°C).
 4. Pulse width and repetition rate should be such as to cause negligible temperature rise.
 5. $E_{on(10\%)} / E_{off(10\%)} / E_{rec(10\%)}$ are the integral of $0.1V_{CE} \times 0.1I_C \times dt$.

CM1200HCB-34N

HIGH POWER SWITCHING USE
INSULATED TYPE

4th-Version HVIGBT (High Voltage Insulated Gate Bipolar Transistor) Modules

PERFORMANCE CURVES

OUTPUT CHARACTERISTICS (TYPICAL)

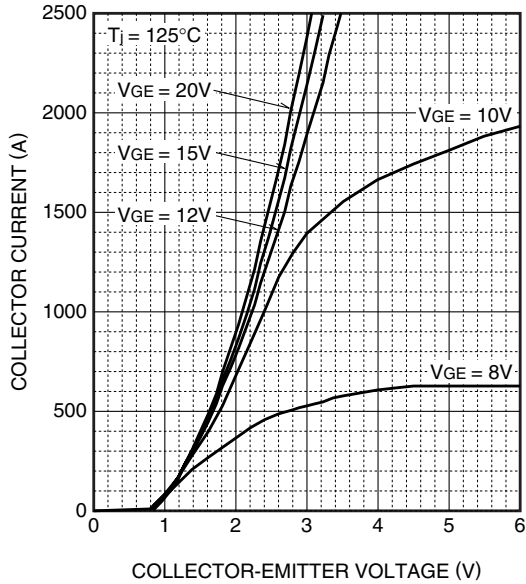

TRANSFER CHARACTERISTICS (TYPICAL)

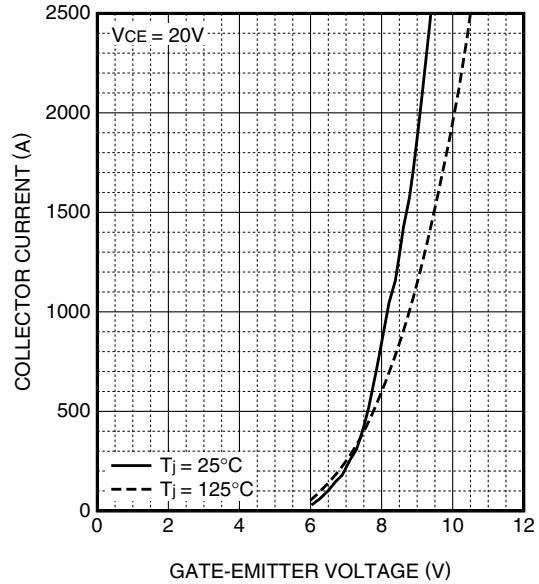

COLLECTOR-EMITTER SATURATION VOLTAGE CHARACTERISTICS (TYPICAL)

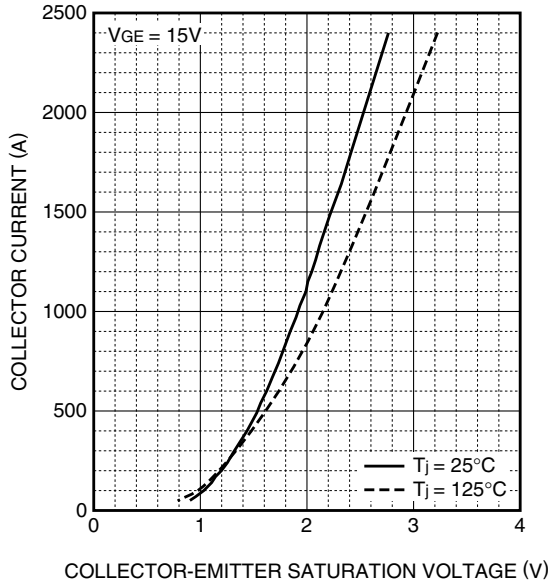

FREE-WHEEL DIODE FORWARD CHARACTERISTICS (TYPICAL)

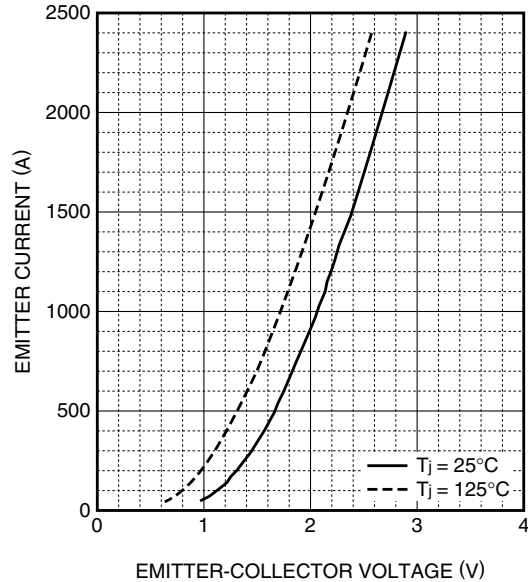

CM1200HCB-34N

HIGH POWER SWITCHING USE
INSULATED TYPE

4th-Version HVIGBT (High Voltage Insulated Gate Bipolar Transistor) Modules

CAPACITANCE CHARACTERISTICS (TYPICAL)

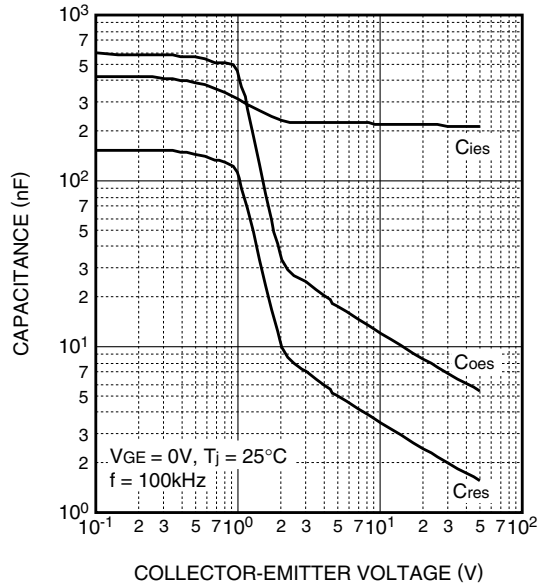

GATE CHARGE CHARACTERISTICS (TYPICAL)

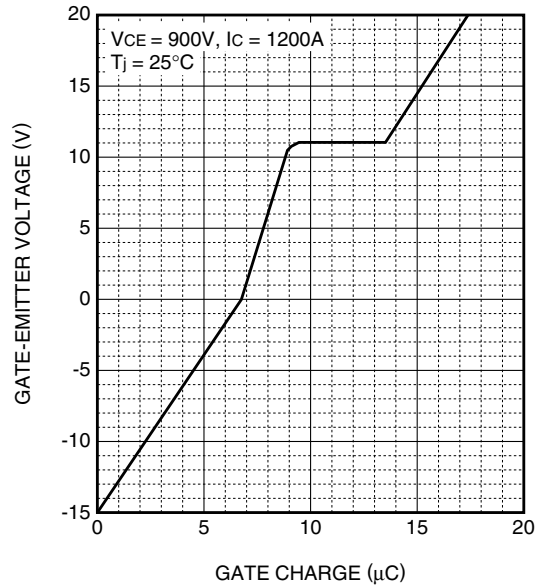

HALF-BRIDGE SWITCHING ENERGY CHARACTERISTICS (TYPICAL)

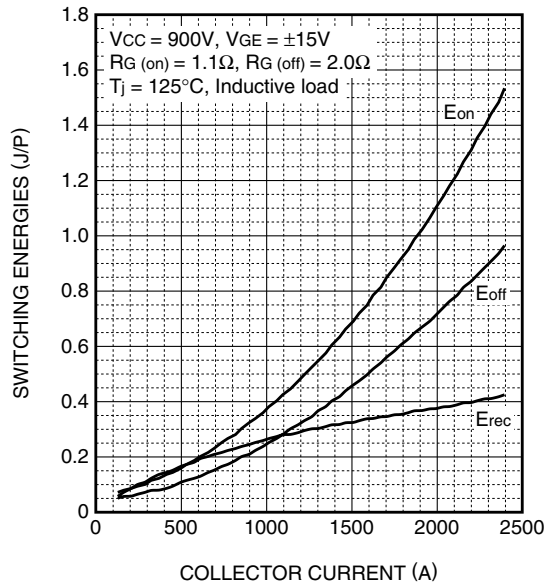

HALF-BRIDGE SWITCHING ENERGY CHARACTERISTICS (TYPICAL)

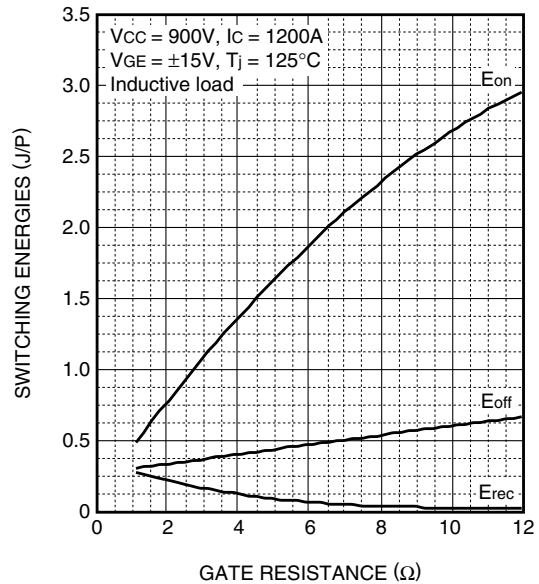

CM1200HCB-34N

HIGH POWER SWITCHING USE
INSULATED TYPE

4th-Version HVIGBT (High Voltage Insulated Gate Bipolar Transistor) Modules

HALF-BRIDGE SWITCHING TIME CHARACTERISTICS (TYPICAL)

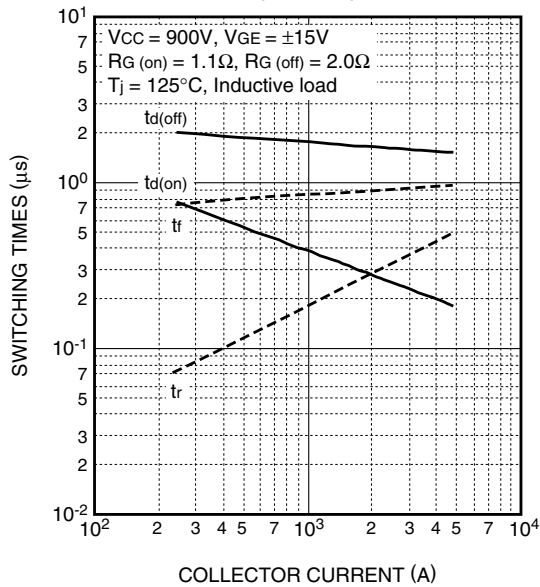

FREE-WHEEL DIODE REVERSE RECOVERY CHARACTERISTICS (TYPICAL)

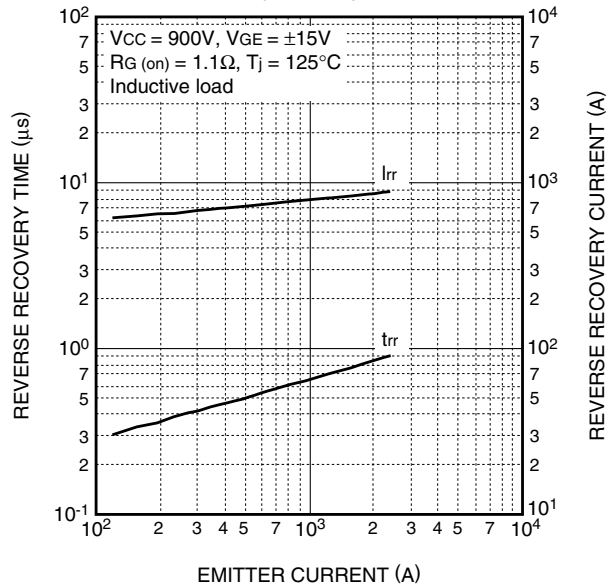

TRANSIENT THERMAL IMPEDANCE CHARACTERISTICS

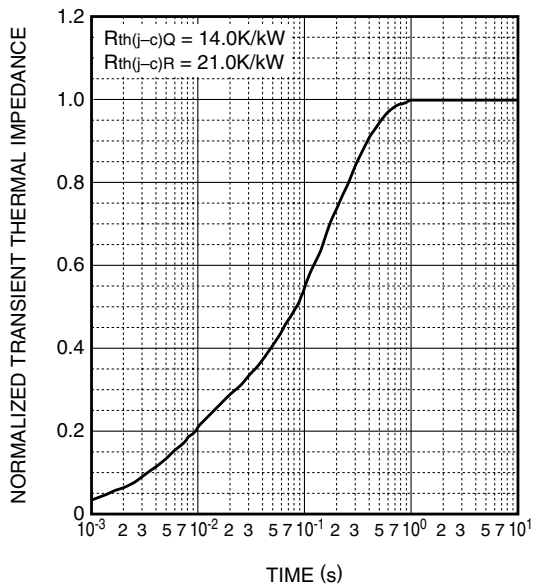

CM1200HCB-34N

HIGH POWER SWITCHING USE
INSULATED TYPE

4th-Version HVIGBT (High Voltage Insulated Gate Bipolar Transistor) Modules

REVERSE BIAS SAFE OPERATING AREA (RBSOA)

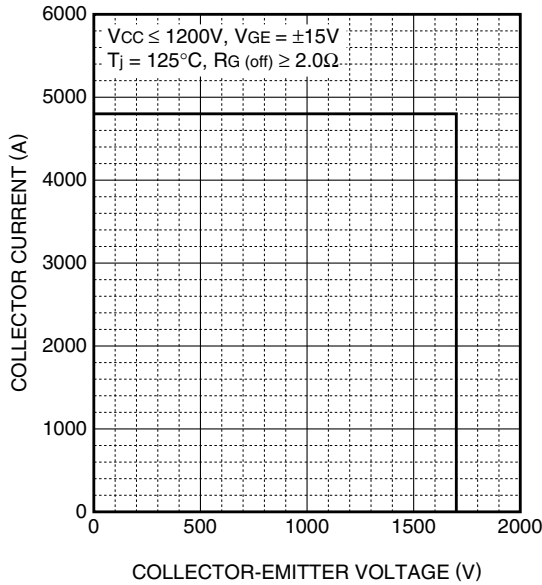

SHORT CIRCUIT SAFE OPERATING AREA (SCSOA)

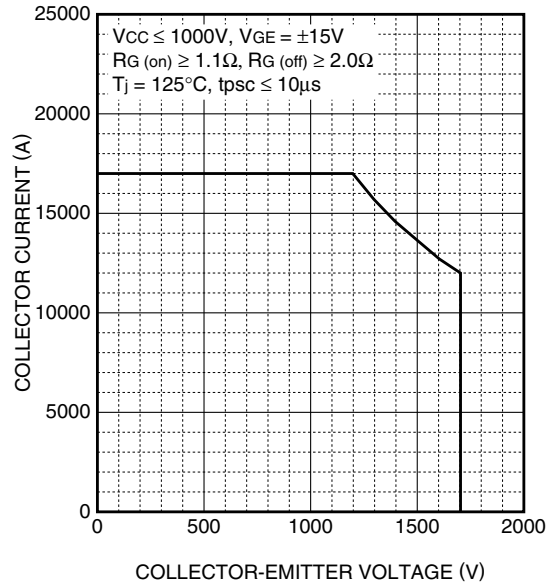

FREE-WHEEL DIODE REVERSE RECOVERY SAFE OPERATING AREA (RRSOA)

